

VERTEX

Drawer Cassetto Cajón
Tiroir Gaveta Szuflada



emuca 
where creation begins

**where
creation
begins**

emuca.com

Index

- 04 Vertex drawer
- 06 Characteristics
- 08 Drawer kit
- 10 Exterior drawer
- 22 Railing
- 24 Inner drawer
- 27 Accessories
- 32 Under-sink insert
- 34 Assembly



vertex



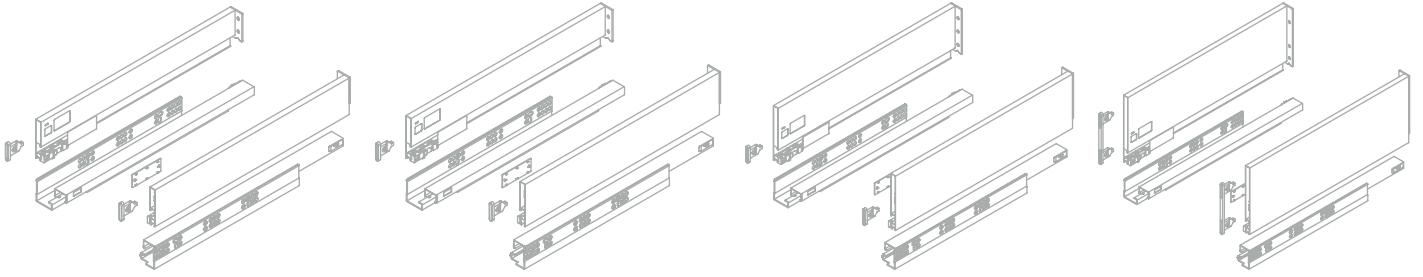

Discover the new Vertex drawer, with an elegant extra fine design and straight lines, perfect to equip your furniture following the latest trends in design and functionality.

Scopri il nuovo cassetto Vertex con un elegante design super fine e linee rette, perfetto per arredare i tuoi mobili con l'ultima tendenza in termini di design e funzionalità.

Descubre el nuevo cajón Vertex con un elegante diseño extrafino de líneas rectas, perfecto para equipar tus muebles con la última tendencia en diseño y funcionalidad.

Découvrez le nouveau tiroir Vertex avec sa conception élégante et son design aux lignes droites, parfait pour équiper vos meubles aux dernières tendances en matière de design et de fonctionnalité.

Descubra a nova gaveta Vertex com um elegante desenho extrafino de linhas direitas, perfeita para equipar os seus móveis de acordo com as últimas tendências tanto em desenho como em funcionalidade.

Przedstawiamy nową szufladę Vertex odznaczającą się wyrafinowanym, eleganckim designem, dzięki której Twoje meble będą prezentować najnowsze trendy zarówno we wzornictwie, jak i funkcjonalności.



Characteristics

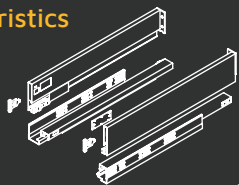



It stands out for its three telescopic runner slides, of reduced height, offering great stability and soft sliding of the drawer. It can support 40 kg and with push to open or soft close and a cushioned pull-out stopper.

Si distingue per le sue guide telescopiche a tre corpi, di altezza ridotta, che offrono una grande stabilità e uno scivolamento morbido del cassetto. Dispongono di una capacità di carico fino a 40 kg, con push o chiusura soft del cassetto e arresto di estrazione ammortizzato.

Destaca por sus guías de tres cuerpos telescópicas, de altura reducida, que ofrecen una gran estabilidad y deslizamiento suave del cajón. Disponen de una capacidad de carga de 40 kg, con push o cierre suave del cajón y tope de extracción amortiguado.

Il se distingue par ses coulisses en 3 parties télescopiques, de hauteur réduite, qui offrent une grande stabilité et un glissement en douceur du tiroir. Il dispose d'une capacité de charge de 40 kg, avec push ou une fermeture douce et un amortisseur en extraction.

Destaca pelas suas corredeiras de três corpos telescópicas, de altura reduzida, que oferecem uma grande estabilidade e um deslizamento muito suave à gaveta. A sua capacidade de carga é de 40 kg, com com tic tac ou fecho suave soft e batente de extração amortecido.

Szuflada ma trzyczęściowe prowadnice teleskopowe o zmniejszonej wysokości, które zapewnią dużą stabilność i płynne przesuwanie Vertex ma udźwig 40 kg, cichy push to open czy domyk i amortyzowany ogranicznik wyciągania.

The drawer's ribs are available in a white satin finish (RAL9003) or anthracite grey (RAL7043) in four different heights (83, 93, 131 and 178 mm) and different depths.

I fianchi del cassetto sono disponibili in finitura bianco satinato (RAL9003) o grigio antracite (RAL7043), con quattro altezze differenti 83, 93, 131 e 178 mm e diverse profondità del cassetto.

Las costillas del cajón están disponibles en acabado blanco satinado (RAL9003) o gris antracita (RAL7043), con cuatro alturas diferentes 83, 93, 131 y 178 mm y distintas profundidades de cajón.

Les parois du tiroir sont disponibles en finition blanc satiné (RAL9003) ou gris anthracite (RAL7043), avec quatre hauteurs différentes 83, 93, 131 et 178 mm et différents profondeurs de tiroir.

As ilhargas de gaveta estão para já disponíveis em acabamento branco satinado (RAL9003) e cinzento antracite (RAL7043), com três alturas diferentes 93, 131 e 178 mm e diferentes profundidades de gaveta.

Boki szuflady są dostępne w kolorze białym satynowym (RAL9003) lub szarym antracytowym (RAL7043), oferujemy te szuflady w czterech różnych wysokościach 83, 93, 131 i 178 mm i różnych głębokościach.

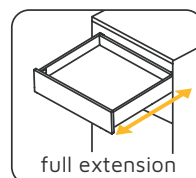
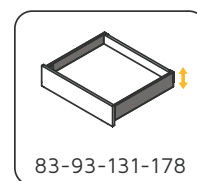
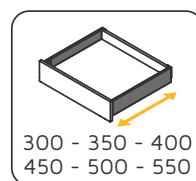
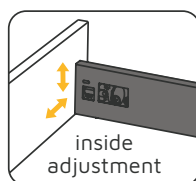
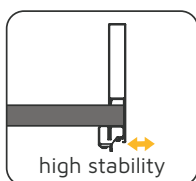
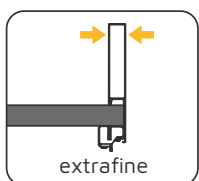

Drawer
kit

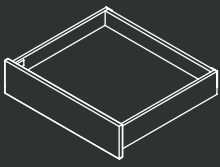

Exterior drawer kit / Kit cassetto esterno / Kit cajón exterior / Kit tiroir extérieur / Kit gaveta exterior / Zestaw szuflady zewnętrznej

KIT

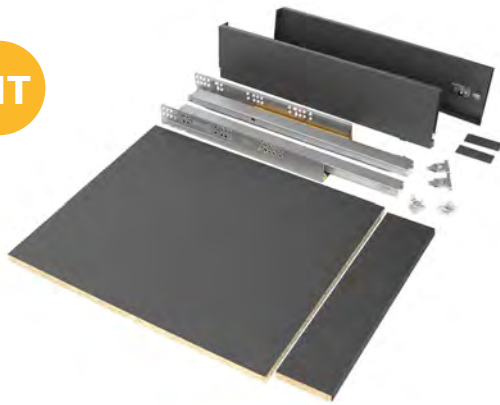

Width	Depth	Finishing	Format	Cod.
450	500	White painted	1 KIT	3173012
600	500	White painted	1 KIT	3173112
900	500	White painted	1 KIT	3173212
450	500	Anthracite grey	1 KIT	3173035
600	500	Anthracite grey	1 KIT	3173135
900	500	Anthracite grey	1 KIT	3173235

Various

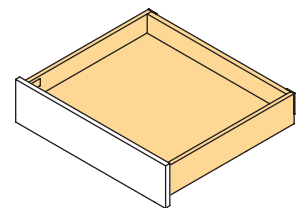
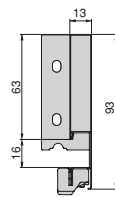

Exterior drawer kit / Kit cassetto esterno / Kit cajón exterior / Kit tiroir extérieur / Kit gaveta exterior / Zestaw szuflady zewnętrznej

KIT



Width	Depth	Finishing	Format	Cod.
450	500	White painted	1 KIT	3173312
600	500	White painted	1 KIT	3173412
900	500	White painted	1 KIT	3173512
450	500	Anthracite grey	1 KIT	3173335
600	500	Anthracite grey	1 KIT	3173435
900	500	Anthracite grey	1 KIT	3173535

Various

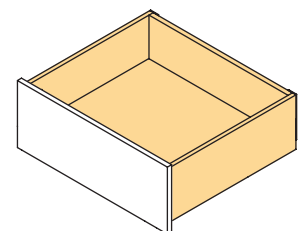
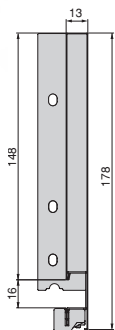

- Includes slides, metal sides, kit of front clip for external drawer, back and bottom.
- Include guide, fianco, coppia di agganci frontali per cassetto esterno, la schiena ed il fondo.
- Incluye guías, costillas, juego de enganches frontales para cajón exterior, trasera y fondo.
- Le kit inclu coulisses, côtés métalliques, jeu d'attaches arrières, jeu d'attaches façade pour tiroir extérieur, l'arrière et le fond de tiroir.
- Inclui corrediças, laterais, jogo de engates frontais para gaveta, traseira e fundo.
- Zawiera prowadnice, metalowe boki, zestaw zacisków frontowych do szuflady zewnętrznej, tyłu i dna.

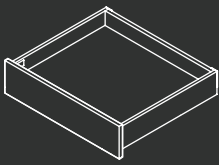

Exterior drawer / Cassetto esterno / Cajón exterior / Tiroir extérieur / Gaveta exterior / Szufłada zewnętrzna

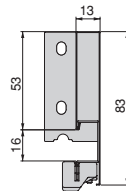

Depth	Finishing	Format	Cod.
450	White painted	1 KIT	3169912
500	White painted	1 KIT	3170012
450	Anthracite grey	1 KIT	3169935
500	Anthracite grey	1 KIT	3170035

Steel

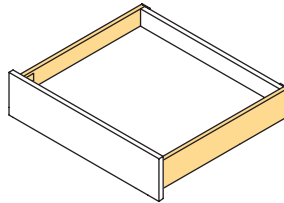

Exterior drawer / Cassetto esterno / Cajón exterior / Tiroir extérieur / Gaveta exterior / Szufłada zewnętrzna

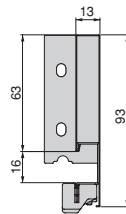
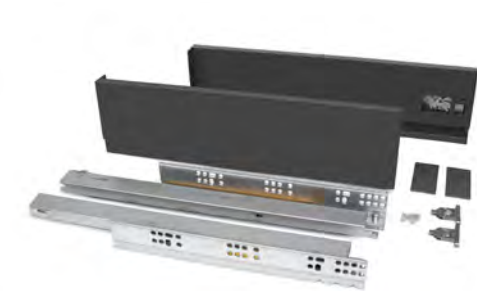

Depth	Finishing	Format	Cod.
300	White painted	1 KIT	3170212
350	White painted	1 KIT	3170312
400	White painted	1 KIT	3170412
450	White painted	1 KIT	3170512
500	White painted	1 KIT	3170612
550	White painted	1 KIT	3170712
300	Anthracite grey	1 KIT	3170235
350	Anthracite grey	1 KIT	3170335
400	Anthracite grey	1 KIT	3170435
450	Anthracite grey	1 KIT	3170535
500	Anthracite grey	1 KIT	3170635
550	Anthracite grey	1 KIT	3170735

Steel

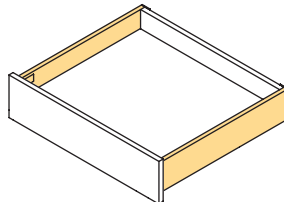

- The code includes all the elements for the assembly of an exterior drawer except the front, back and bottom.
- Includes slides, metal sides and kit of front clip for external drawer.
- Il codice include tutti gli elementi per il montaggio di un cassetto esterno ad eccezione del frontale, la schiena ed il fondo.
- Include guide, fianco e coppia di agganci frontali per cassetto esterno.
- El código incluye todos los elementos para el montaje de un cajón exterior a excepción de la frontera, trasera y fondo.
- Incluye guías, costillas y juego de enganches frontales para cajón exterior.

Exterior drawer / Cassetto esterno / Cajón exterior / Tiroir extérieur / Gaveta exterior / Szuflada zewnętrzna

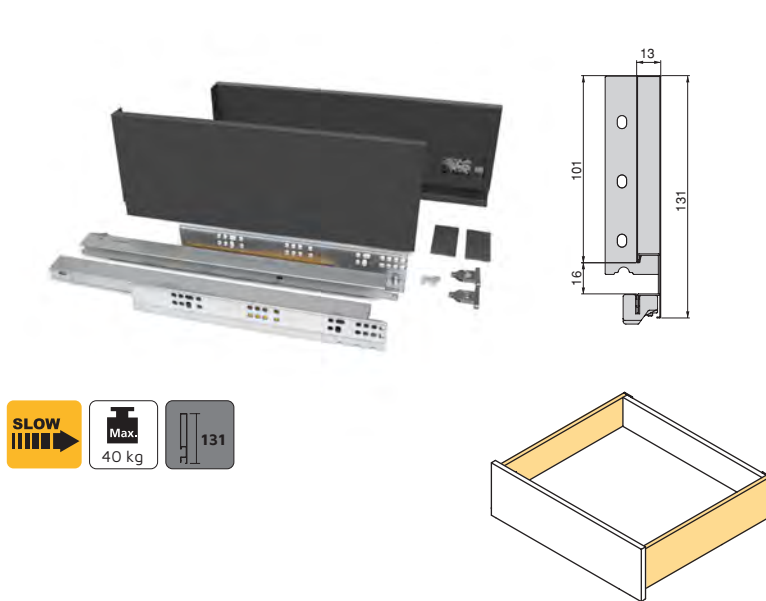

Depth	Finishing	Format	Cod.
300	White painted	1 KIT	3170912
350	White painted	1 KIT	3171012
400	White painted	1 KIT	3171112
450	White painted	1 KIT	3171212
500	White painted	1 KIT	3171312
300	Anthracite grey	1 KIT	3170935
350	Anthracite grey	1 KIT	3171035
400	Anthracite grey	1 KIT	3171135
450	Anthracite grey	1 KIT	3171235
500	Anthracite grey	1 KIT	3171335

Steel

Exterior drawer / Cassetto esterno / Cajón exterior / Tiroir extérieur / Gaveta exterior / Szuflada zewnętrzna

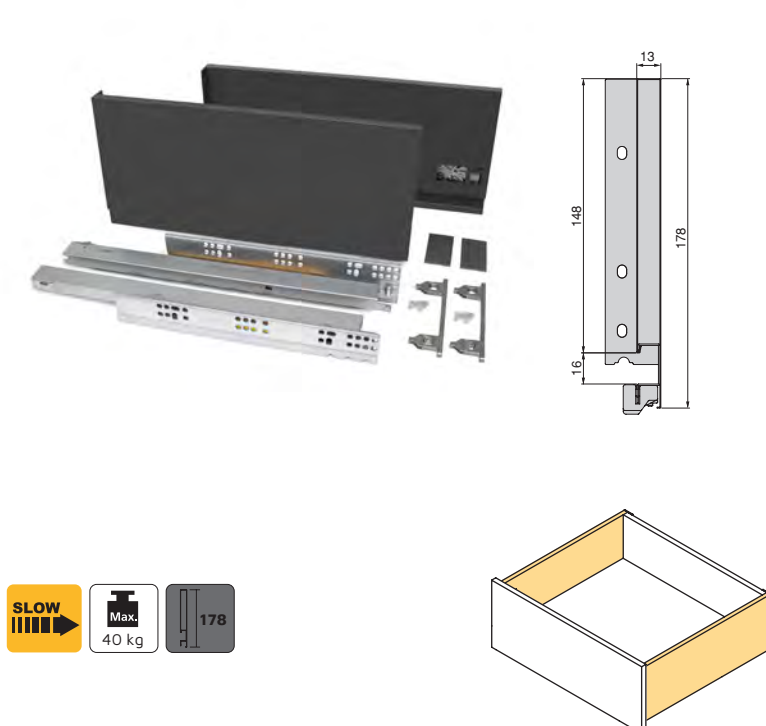

Depth	Finishing	Format	Cod.
350	White painted	1 KIT	3171612
400	White painted	1 KIT	3171712
450	White painted	1 KIT	3171812
500	White painted	1 KIT	3171912
350	Anthracite grey	1 KIT	3171635
400	Anthracite grey	1 KIT	3171735
450	Anthracite grey	1 KIT	3171835
500	Anthracite grey	1 KIT	3171935

Steel

- Chaque kit inclu tous les éléments pour monter un tiroir sauf la façade avant, l'arrière et le fond de tiroir.
- Le kit inclu coulisses, côtés métalliques et jeu d'attaches façade pour tiroir extérieur.
- O código inclui todos os elementos para a montagem de uma gaveta exterior à exceção da frente, traseira e fundo.
- Incluir corredeiras, laterais e jogo de engates frontais para gaveta.
- Kod zawiera wszystkie elementy do montażu szuflady zewnętrznej z wyjątkiem frontu, tyłu i dna.
- Zawiera prowadnice, metalowe boki, zestaw zacisków frontowych do szuflady zewnętrznej.

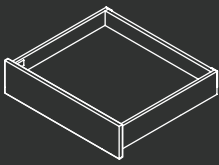

Exterior drawer / Cassetto esterno / Cajón exterior / Tiroir extérieur / Gaveta exterior / Szufłada zewnętrzna



Depth	Finishing	Format	Cod.
350	White painted	1 KIT	3197012
400	White painted	1 KIT	3197112
450	White painted	1 KIT	3197212
500	White painted	1 KIT	3197312
350	Anthracite grey	1 KIT	3197035
400	Anthracite grey	1 KIT	3197135
450	Anthracite grey	1 KIT	3197235
500	Anthracite grey	1 KIT	3197335

Various

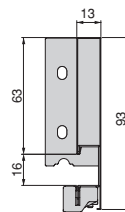
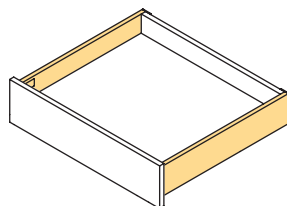

- The code includes all the elements for the assembly of an exterior drawer except the front, back and bottom.
- Includes slides, metal sides and kit of front clip for external drawer.
- Il codice include tutti gli elementi per il montaggio di un cassetto esterno ad eccezione del frontale, la schiena ed il fondo.
- Include guide, fianco e coppia di agganci frontali per cassetto esterno.
- El código incluye todos los elementos para el montaje de un cajón exterior a excepción de la frontera, trasera y fondo.
- Incluye guías, costillas y juego de enganches frontales para cajón exterior.

Exterior drawer / Cassetto esterno / Cajón exterior / Tiroir extérieur / Gaveta exterior / Szuflada zewnętrzna

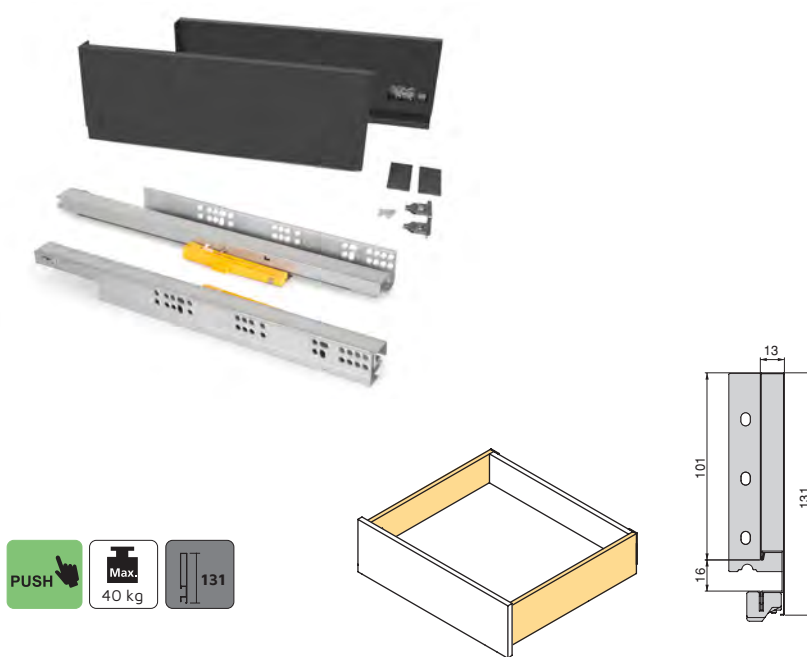

Depth	Finishing	Format	Cod.
350	White painted	1 KIT	3197412
400	White painted	1 KIT	3197512
450	White painted	1 KIT	3197612
500	White painted	1 KIT	3197712
350	Anthracite grey	1 KIT	3197435
400	Anthracite grey	1 KIT	3197535
450	Anthracite grey	1 KIT	3197635
500	Anthracite grey	1 KIT	3197735

Various

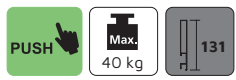

Exterior drawer / Cassetto esterno / Cajón exterior / Tiroir extérieur / Gaveta exterior / Szuflada zewnętrzna

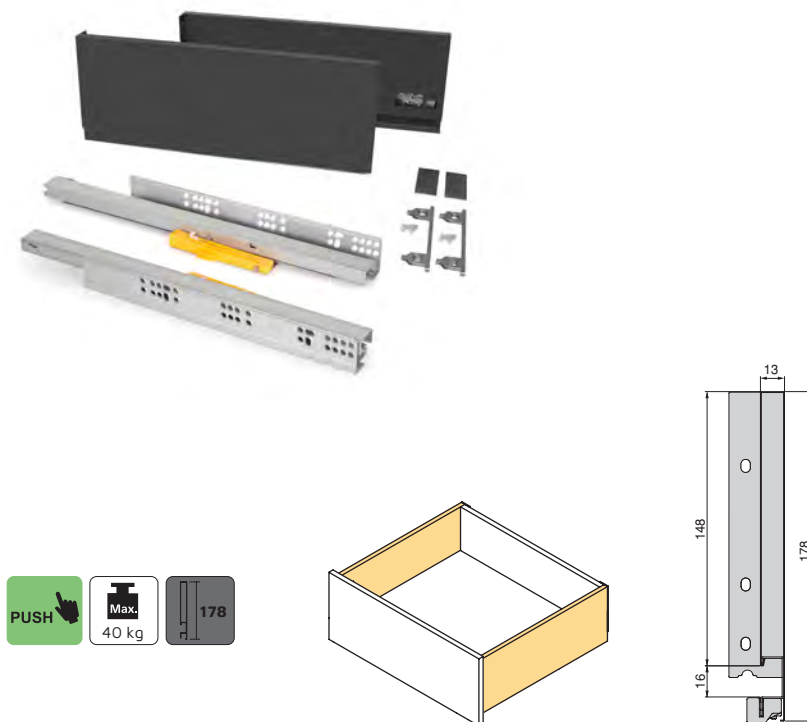

Depth	Finishing	Format	Cod.
350	White painted	1 KIT	3197812
400	White painted	1 KIT	3197912
450	White painted	1 KIT	3198012
500	White painted	1 KIT	3198112
350	Anthracite grey	1 KIT	3197835
400	Anthracite grey	1 KIT	3197935
450	Anthracite grey	1 KIT	3198035
500	Anthracite grey	1 KIT	3198135

Various



- Chaque kit inclu tous les éléments pour monter un tiroir sauf la façade avant, l'arrière et le fond de tiroir.
- Le kit inclu coulisses, côtés métalliques et jeu d'attaches façade pour tiroir extérieur.
- O código inclui todos os elementos para a montagem de uma gaveta exterior à exceção da frente, traseira e fundo.
- Includi corrediças, laterais e jogo de engates frontais para gaveta.
- Kod zawiera wszystkie elementy do montażu szuflady zewnętrznej z wyjątkiem frontu, tyłu i dna.
- Zawiera prowadnice, metalowe boki, zestaw zacisków frontowych do szuflady zewnętrznej.

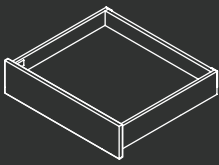

Exterior drawer / Cassetto esterno / Cajón exterior / Tiroir extérieur / Gaveta exterior / Szuflada zewnętrzna

Depth	Finishing	Format	Cod.
450	Anthracite grey	1 KIT	3130035
500	Anthracite grey	1 KIT	3130135

Various

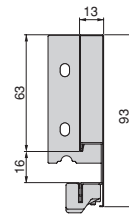
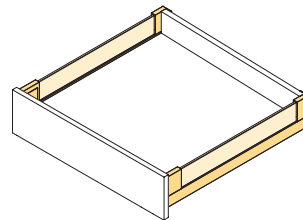

- The code includes all the elements for the assembly of an exterior drawer except the front, back and bottom.
- Includes slides, metal sides and kit of front clip for external drawer.
- Il codice include tutti gli elementi per il montaggio di un cassetto esterno ad eccezione del frontale, la schiena ed il fondo.
- Include guide, fianco e coppia di agganci frontali per cassetto esterno.
- El código incluye todos los elementos para el montaje de un cajón exterior a excepción de la frontera, trasera y fondo.
- Incluye guías, costillas y juego de enganches frontales para cajón exterior.

Exterior drawer / Cassetto esterno / Cajón exterior / Tiroir extérieur / Gaveta exterior / Szuflada zewnętrzna

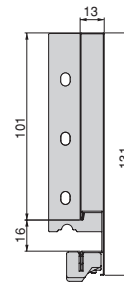
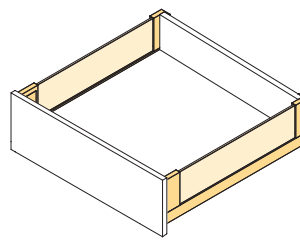

Depth	Finishing	Format	Cod.
450	Anthracite grey	1 KIT	3130235
500	Anthracite grey	1 KIT	3130335

Various

Exterior drawer / Cassetto esterno / Cajón exterior / Tiroir extérieur / Gaveta exterior / Szuflada zewnętrzna

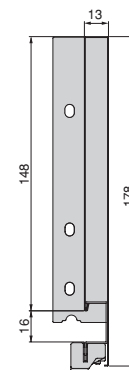
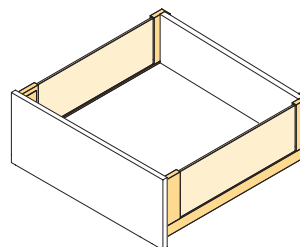

Depth	Finishing	Format	Cod.
450	Anthracite grey	1 KIT	3130435
500	Anthracite grey	1 KIT	3130535

Various

- Chaque kit inclu tous les éléments pour monter un tiroir sauf la façade avant, l'arrière et le fond de tiroir.
- Le kit inclu coulisses, côtés métalliques et jeu d'attaches façade pour tiroir extérieur.
- O código inclui todos os elementos para a montagem de uma gaveta exterior à exceção da frente, traseira e fundo.
- Incluir corredeiras, laterais e jogo de engates frontais para gaveta.
- Kod zawiera wszystkie elementy do montażu szuflady zewnętrznej z wyjątkiem frontu, tyłu i dna.
- Zawiera prowadnice, metalowe boki, zestaw zacisków frontowych do szuflady zewnętrznej.

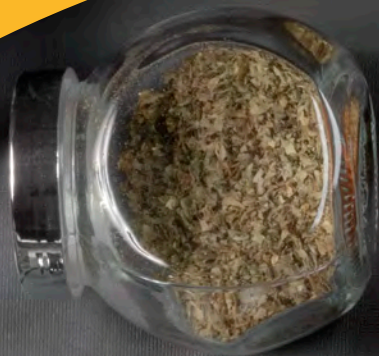



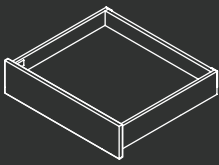



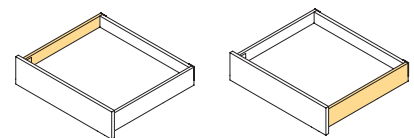













Sides / Fianchi / Costillas / Côtés / Laterais / Boki



	Depth	Finishing	Format	Cod.
Left	350	White painted 	20 Ut	3180212
Left	400	White painted 	20 Ut	3184212
Left	450	White painted 	20 Ut	3180612
Left	500	White painted 	20 Ut	3180812
Left	350	Anthracite grey 	20 Ut	3180235
Left	400	Anthracite grey 	20 Ut	3184235
Left	450	Anthracite grey 	20 Ut	3180635
Left	500	Anthracite grey 	20 Ut	3180835

Steel

	Depth	Finishing	Format	Cod.
Right	350	White painted 	20 Ut	3180312
Right	400	White painted 	20 Ut	3184312
Right	450	White painted 	20 Ut	3180712
Right	500	White painted 	20 Ut	3180912
Right	350	Anthracite grey 	20 Ut	3180335
Right	400	Anthracite grey 	20 Ut	3184335
Right	450	Anthracite grey 	20 Ut	3180735
Right	500	Anthracite grey 	20 Ut	3180935

Steel

Sides / Fianchi / Costillas / Côtés / Laterais / Boki

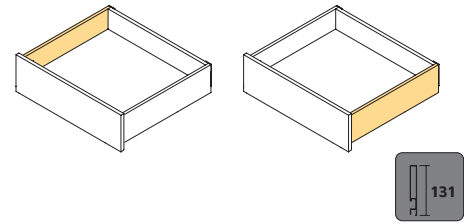
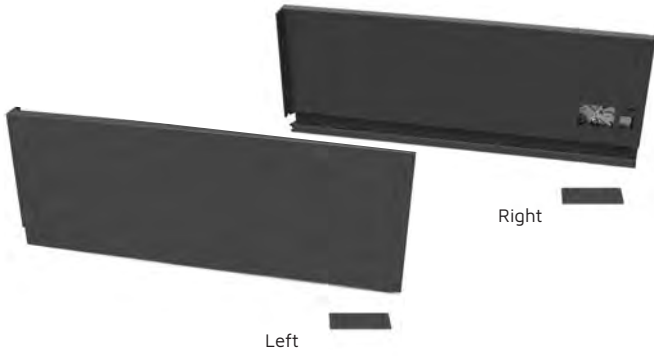

	Depth	Finishing	Format	Cod.
Left	350	White painted	20 Ut	3181612
Left	400	White painted	20 Ut	3184412
Left	450	White painted	20 Ut	3182012
Left	500	White painted	20 Ut	3182212
Left	350	Anthracite grey	20 Ut	3181635
Left	400	Anthracite grey	20 Ut	3184435
Left	450	Anthracite grey	20 Ut	3182035
Left	500	Anthracite grey	20 Ut	3182235

Steel

	Depth	Finishing	Format	Cod.
Right	350	White painted	20 Ut	3181712
Right	400	White painted	20 Ut	3184512
Right	450	White painted	20 Ut	3182112
Right	500	White painted	20 Ut	3182312
Right	350	Anthracite grey	20 Ut	3181735
Right	400	Anthracite grey	20 Ut	3184535
Right	450	Anthracite grey	20 Ut	3182135
Right	500	Anthracite grey	20 Ut	3182335

Steel

Sides / Fianchi / Costillas / Côtés / Laterais / Boki

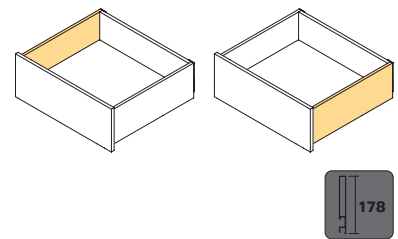
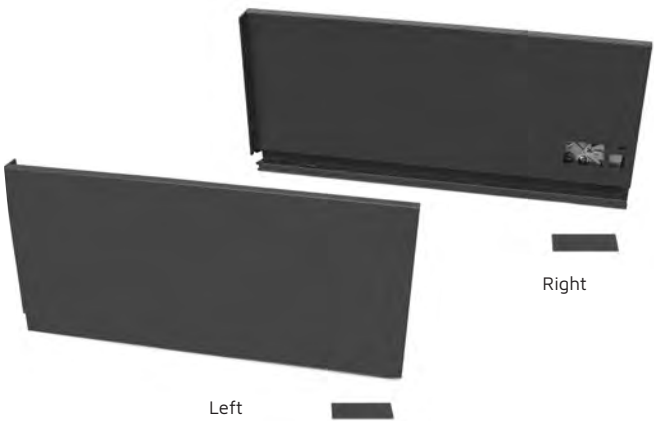

	Depth	Finishing	Format	Cod.
Left	350	White painted	10 Ut	3183012
Left	400	White painted	10 Ut	3184612
Left	450	White painted	10 Ut	3183412
Left	500	White painted	10 Ut	3183612
Left	350	Anthracite grey	10 Ut	3183035
Left	400	Anthracite grey	10 Ut	3184635
Left	450	Anthracite grey	10 Ut	3183435
Left	500	Anthracite grey	10 Ut	3183635

Steel

	Depth	Finishing	Format	Cod.
Right	350	White painted	10 Ut	3183112
Right	400	White painted	10 Ut	3184712
Right	450	White painted	10 Ut	3183512
Right	500	White painted	10 Ut	3183712
Right	350	Anthracite grey	10 Ut	3183135
Right	400	Anthracite grey	10 Ut	3184735
Right	450	Anthracite grey	10 Ut	3183535
Right	500	Anthracite grey	10 Ut	3183735

Steel

Slides / Guide / Guías / Coulisses / Corrediças / Prowadnice



	Depth	Finishing	Format	Cod.
Left	350	Zinc plated	20 Ut	3177405
Left	400	Zinc plated	20 Ut	3177605
Left	450	Zinc plated	20 Ut	3177805
Left	500	Zinc plated	20 Ut	3178005

Steel

	Depth	Finishing	Format	Cod.
Right	350	Zinc plated	20 Ut	3177505
Right	400	Zinc plated	20 Ut	3177705
Right	450	Zinc plated	20 Ut	3177905
Right	500	Zinc plated	20 Ut	3178105

Steel

Clips / Agganci / Enganches / Attaches / Engates / Zacisków

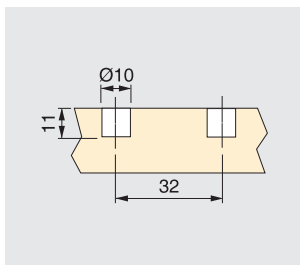

Description	Finishing	Format	Cod.
Screw-on	Zinc plated	100 Pair	3104005
Knock-in Ø10 x 11	Zinc plated	100 Pair	3104105

Steel

Clips / Agganci / Enganches / Attaches / Engates / Zacisków

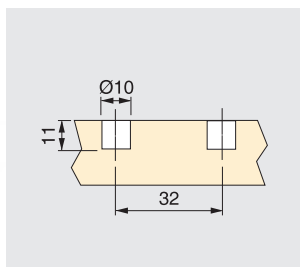

Description	Finishing	Format	Cod.
Screw-on	Zinc plated	50 Pair	3176005
Knock-in Ø10 x 11	Zinc plated	50 Pair	3176105

Steel



Railing

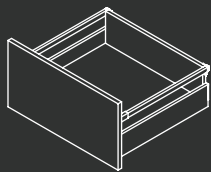

Set of railing / Coppia di astine / Juego de barandillas / Jeu de réhausses / Jogo de cercos / Zestaw bocznego

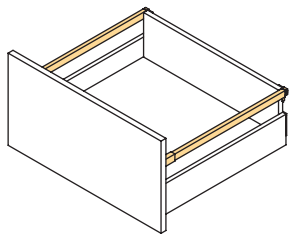

Depth	Finishing	Format	Cod.
300	White painted	20 Pair	3110112
350	White painted	20 Pair	3110212
400	White painted	20 Pair	3110312
450	White painted	20 Pair	3110412
500	White painted	20 Pair	3110512
550	White painted	20 Pair	3110712
300	Anthracite grey	20 Pair	3110135
350	Anthracite grey	20 Pair	3110235
400	Anthracite grey	20 Pair	3110335
450	Anthracite grey	20 Pair	3110435
500	Anthracite grey	20 Pair	3110535
550	Anthracite grey	20 Pair	3110735

Steel

Front fixing / Aggancio frontale / Enganche frontal / Fixation frontale / Engate frontal / Przykręcany frontowy



- For timber fronts we recommend Ø3,5 mm screws.
- Per frontalini in legno si raccomanda utilizzare viti Ø3,5 mm.
- Para frentes de madera se recomienda tornillo de Ø3,5 mm.
- Pour façade en bois nous conseillons Ø3,5 mm.
- Para frentes de madeira recomenda-se o parafuso Ø3,5 mm.
- Dla frontów z drewna zalecamy śruby Ø3,5 mm.

Finishing	Format	Cod.
Grey plastic	200 Ut	3110021

Plastic

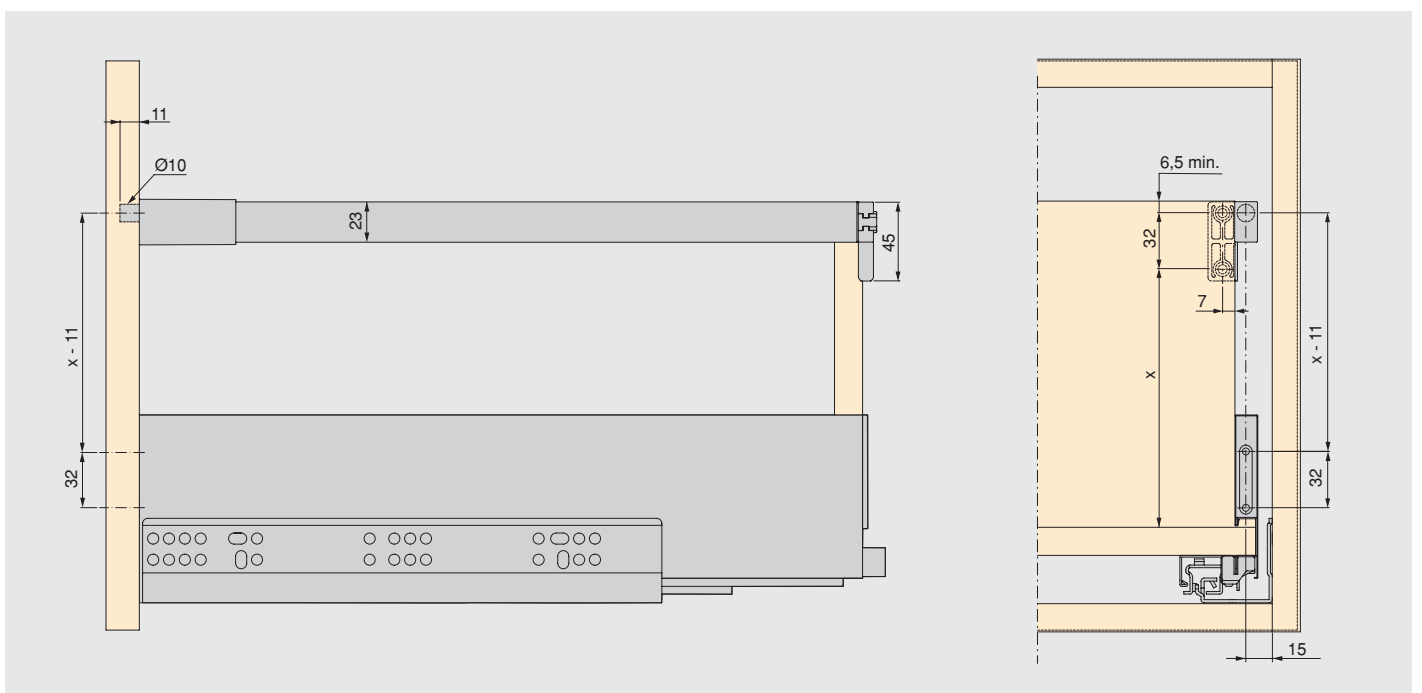

Inner
drawer

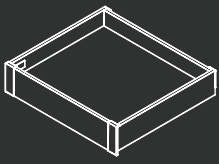

Set of fittings / Coppia di agganci / Juego de enganches / Jeu d'attaches / Jogo de engates / Zestaw frontowych

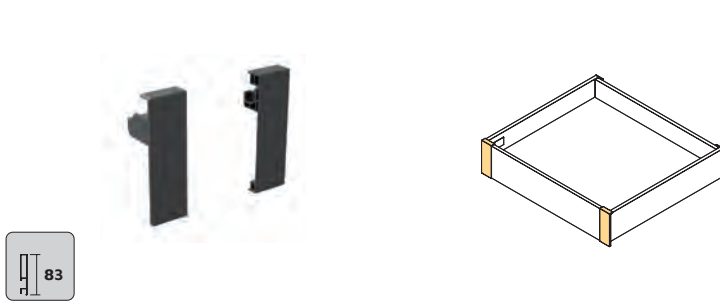

Height	Finishing	Format	Cod.
83	White plastic	4 Pair	3172015
83	Anthracite grey plastic	4 Pair	3172023

Plastic

Set of fittings / Coppia di agganci / Juego de enganches / Jeu d'attaches / Jogo de engates / Zestaw frontowych

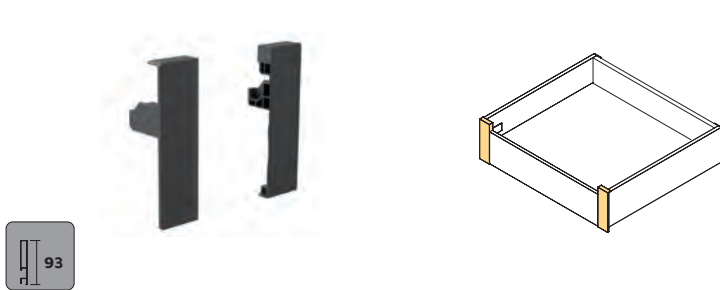

Height	Finishing	Format	Cod.
93	White plastic	4 Pair	3172115
93	Anthracite grey plastic	4 Pair	3172123

Plastic

Set of fittings / Coppia di agganci / Juego de enganches / Jeu d'attaches / Jogo de engates / Zestaw frontowych

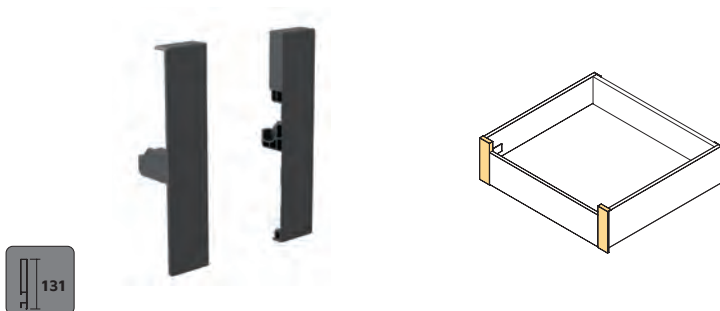

Height	Finishing	Format	Cod.
131	White plastic	4 Pair	3172215
131	Anthracite grey plastic	4 Pair	3172223

Plastic

Set of fittings / Coppia di agganci / Juego de enganches / Jeu d'attaches / Jogo de engates / Zestaw frontowych

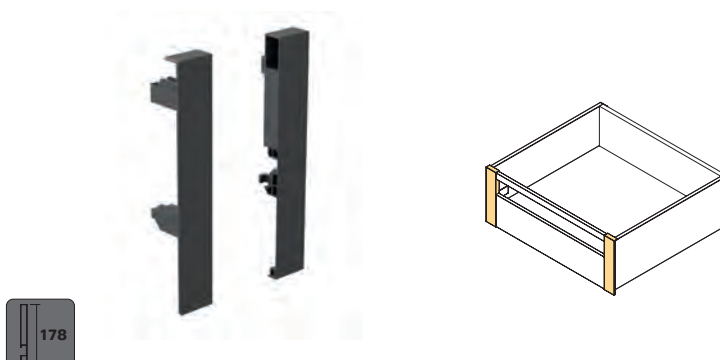

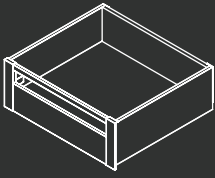

Height	Finishing	Format	Cod.
178	White plastic	4 Pair	3172315
178	Anthracite grey plastic	4 Pair	3172323

Plastic

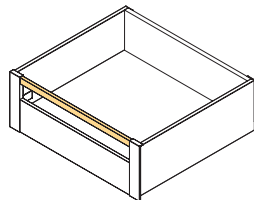
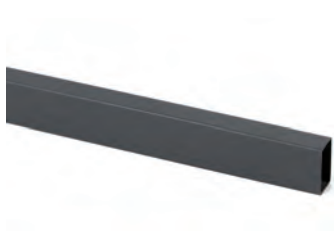

Frontal railing / Astina frontale / Barandilla frontal / Réhausse frontale / Cerco frontal / Reling frontowy



Height	Longitude	Finishing	Format	Cod.
178	1,12 m	White painted 	10 Ut/Szt	3113412
178	1,12 m	Anthracite grey 	10 Ut/Szt	3113435

Aluminium

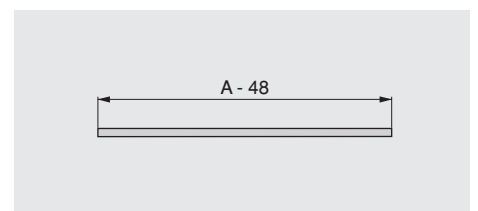

A= Module inner size / Interno modulo / Interior módulo / Interieur caisson
Interior de módulo / Rozmiar wewnętrzny modułu

Frontal profile / Profilo frontale / Perfil frontal / Profil frontal / Perfil frontal / Profil frontowy

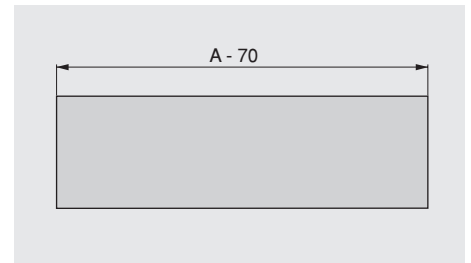
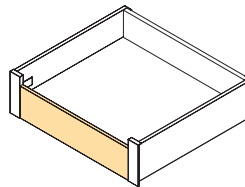
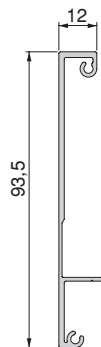

Longitude	Finishing	Format	Cod.
1,10 m	White painted	10 Ut	3172412
1,10 m	Anthracite grey	10 Ut	3172435

Aluminium

Lateral spacers / Distanziale laterale / Distanciadores laterales / Séparateurs latéraux / Distanciadores laterais / Podkładki dystansowe



Finishing	Format	Cod.
White plastic	4 Ut	3110815
Anthracite grey plastic	4 Ut	3110823

Plastic

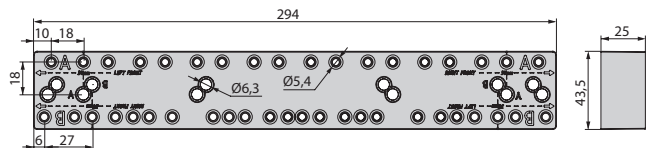

o screws.

- Permette el montaggio con porte incernierate. include viti Euro.
- Permite el montaje con puertas abisagradas. Incluye tornillos Euro.
- Permet le montage avec des portes à charnières. Comprend des Eurovis.
- Permite a montagem com portas com dobradiças. Inclui parafusos Euro.
- Umożliwia montaż drzwi z zawiasami. Zawiera eurowkręty.

Synchronizer set for push to open slides for Vertex drawer



Finishing	Format	Cod.
Natural aluminium	10 UN/UN	3198261

Aluminium



M>600
SYNCHRO SISTEM

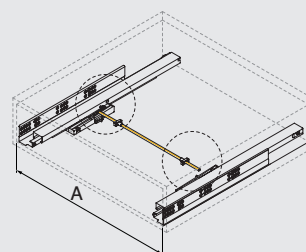
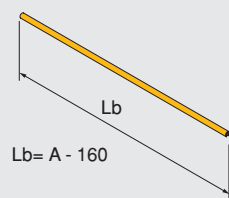
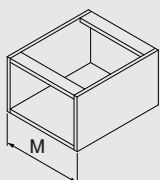

Template to fix / Sagoma di foratura / Juego de plantillas / Jeu de gabarits / Jogo de bitolas / Szablon do mocowania



Finishing	Format	Cod.
Grey plastic 	1 Pair	3114021

Plastic

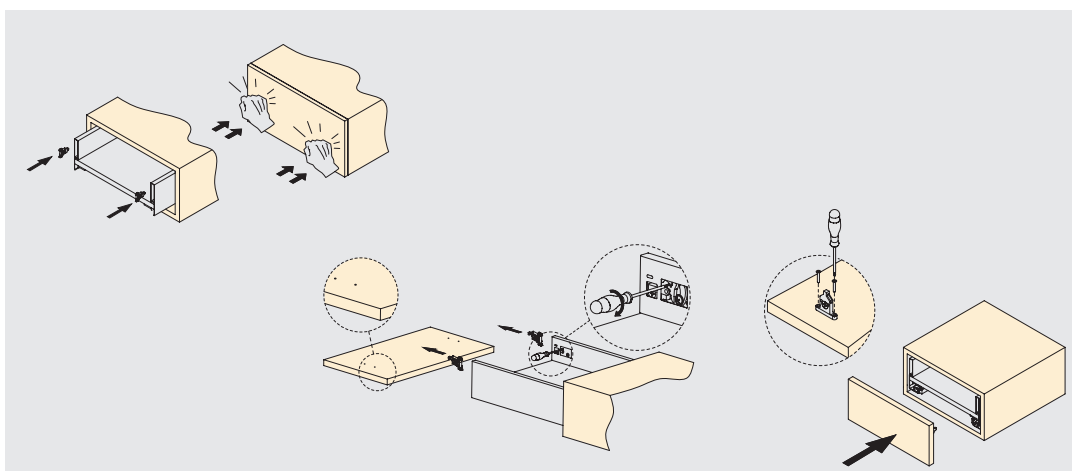

Lokbox union / Unione Lokbox / Unión Lokbox / Union Lokbox / União Lokbox / Łącznik Lokbox



Finishing	Format	Cod.
Grey plastic 	100 Ut	3002621

Plastic

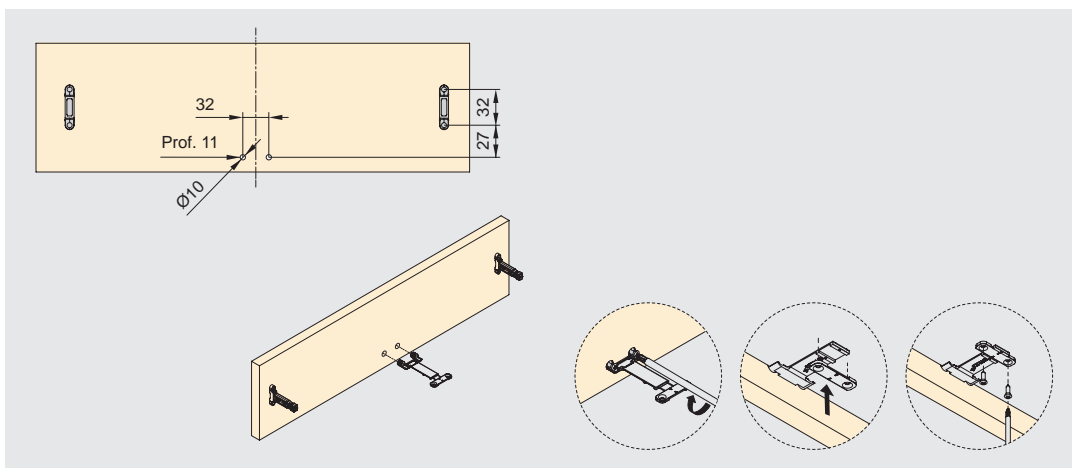



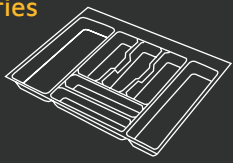





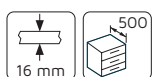
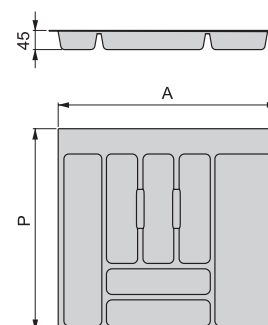

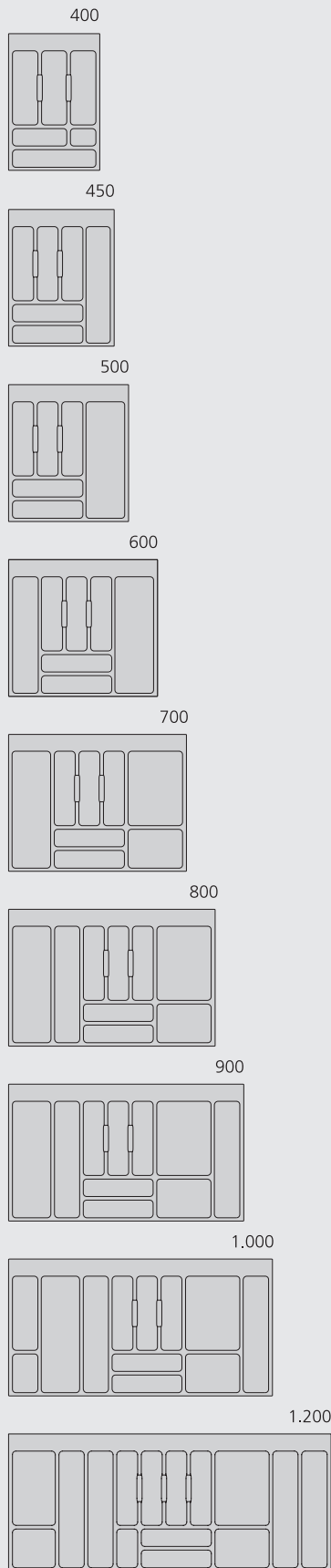



























OPTIMA

Cutlery trays / Portaposate / Cuberteros / Range-couverts / Porta-talheres / Wkłady szufladowe





Board thickness	M	A	P	Finishing	Format	Cod.
16	400	322	473	White plastic		1 Ut 8333015
16	400	322	473	White plastic		20 Ut 8325815
16	450	372	473	White plastic		1 Ut 8333115
16	450	372	473	White plastic		20 Ut 8325915
16	500	422	473	White plastic		1 Ut 8333215
16	500	422	473	White plastic		20 Ut 8326015
16	600	522	473	White plastic		1 Ut 8333315
16	600	522	473	White plastic		20 Ut 8326115
16	700	622	473	White plastic		1 Ut 8333415
16	700	622	473	White plastic		10 Ut 8331615
16	800	722	473	White plastic		1 Ut 8333515
16	800	722	473	White plastic		10 Ut 8331715
16	900	822	473	White plastic		1 Ut 8333615
16	900	822	473	White plastic		10 Ut 8331815
16	1.000	922	473	White plastic		1 Ut 8333715
16	1.000	922	473	White plastic		10 Ut 8331915
16	1.200	1.122	473	White plastic		10 Ut 8326615
16	400	322	473	Anthracite grey plastic		1 Ut 8333023
16	400	322	473	Anthracite grey plastic		20 Ut 8325823
16	450	372	473	Anthracite grey plastic		1 Ut 8333123
16	450	372	473	Anthracite grey plastic		20 Ut 8325923
16	500	422	473	Anthracite grey plastic		1 Ut 8333223
16	500	422	473	Anthracite grey plastic		20 Ut 8326023
16	600	522	473	Anthracite grey plastic		1 Ut 8333323
16	600	522	473	Anthracite grey plastic		20 Ut 8326123
16	700	622	473	Anthracite grey plastic		1 Ut 8333423
16	700	622	473	Anthracite grey plastic		10 Ut 8331623
16	800	722	473	Anthracite grey plastic		1 Ut 8333523
16	800	722	473	Anthracite grey plastic		10 Ut 8331723
16	900	822	473	Anthracite grey plastic		1 Ut 8333623
16	900	822	473	Anthracite grey plastic		10 Ut 8331823
16	1.000	922	473	Anthracite grey plastic		1 Ut 8333723
16	1.000	922	473	Anthracite grey plastic		10 Ut 8331923
16	1.200	1.122	473	Anthracite grey plastic		10 Ut 8326623

Plastic

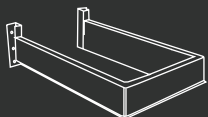

Under-sink insert / Salva sifone / Salva sifón / Sous-évier / Salva-sifão / Prostokątna wstawka

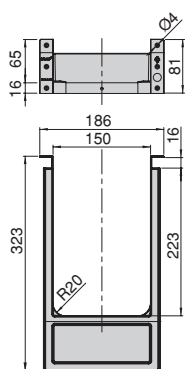

Finishing	Format	Cod.
White plastic	6 Ut	3044115
Anthracite grey plastic	6 Ut	3044123

Plastic

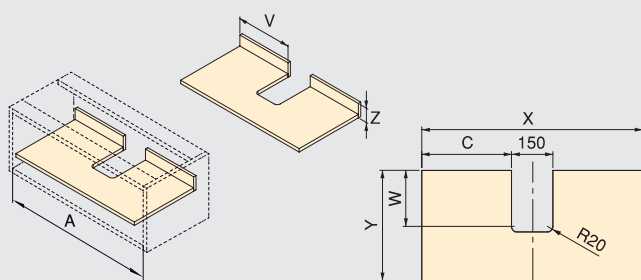

C	V	W	X	Y	Z	
(A - 169) / 2	(A - 192) / 2	220	A - 19	Prof. - 10	63	
		204		Prof. - 26	81	

Under-sink insert / Schiena sagomata / Bajo fregadero / Sous-évier / Salva-sifão / Wstawka podumywalkowa

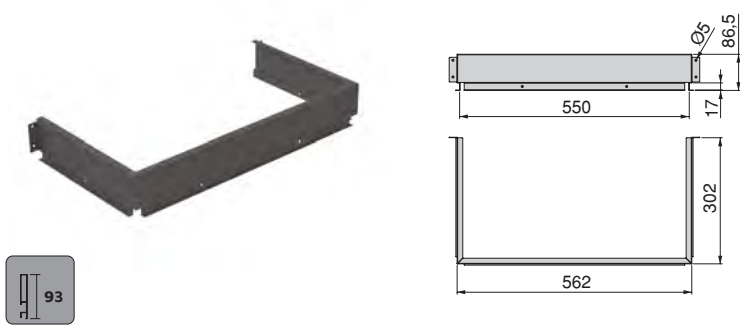

Finishing	Format	Cod.
White painted	10 Ut	3017912
Anthracite grey	10 Ut	3017935

Aluminium, Steel

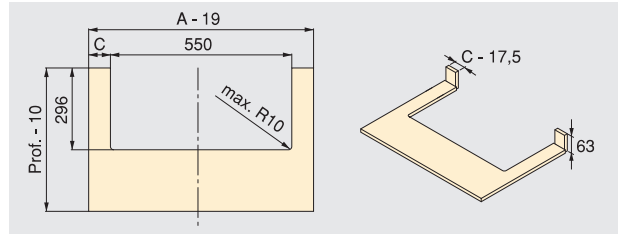

Under-sink insert / Salva sifone / Salva sifón / Sous-évier / Salva-sifão / Prostokątna wstawka

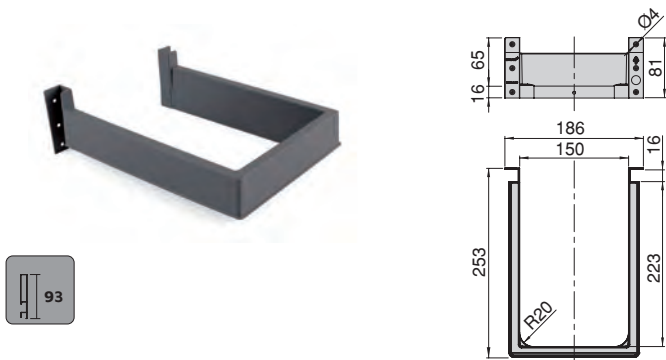

Finishing	Format	Cod.
White plastic	10 Ut	3044215
Anthracite grey plastic	10 Ut	3044223

Plastic

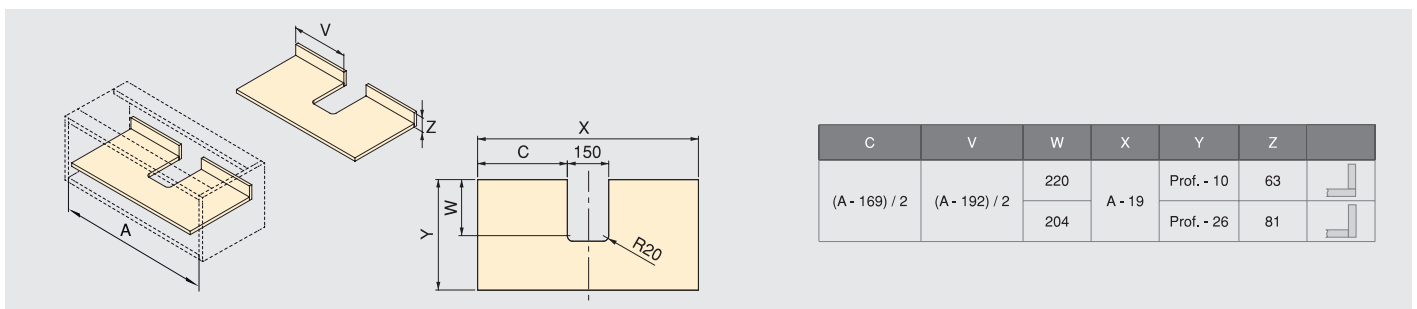

Under-sink insert / Salva sifone / Salva sifón / Sous-évier / Salva-sifão / Prostokątna wstawka

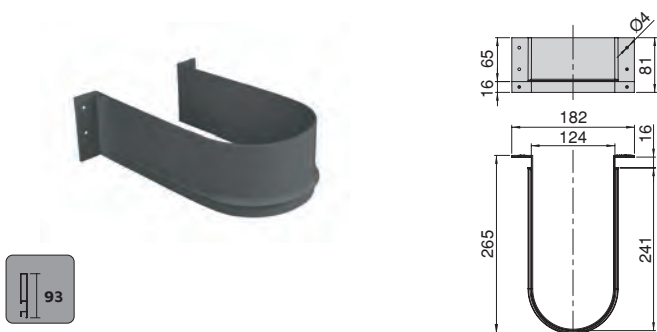

Finishing	Format	Cod.
White plastic	10 Ut	3044315
White plastic	100 Ut	3044415
Anthracite grey plastic	100 Ut	3044423
Anthracite grey plastic	10 Ut	3044323

Plastic

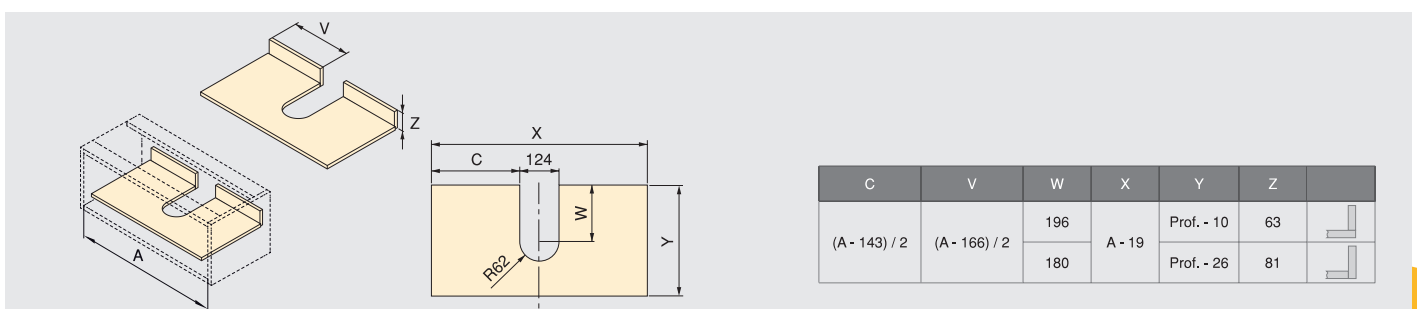

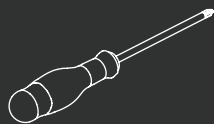

INFORMATION

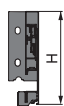
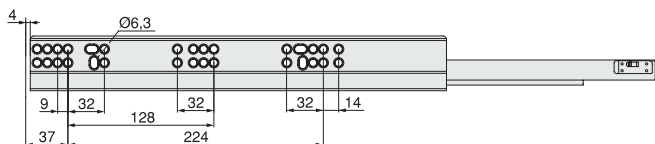

H
83
93
131
178

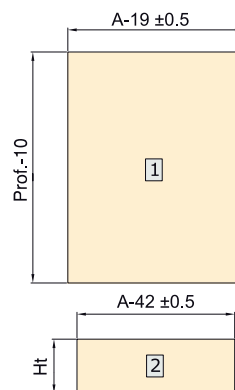
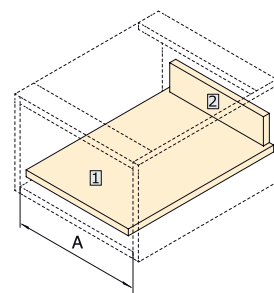
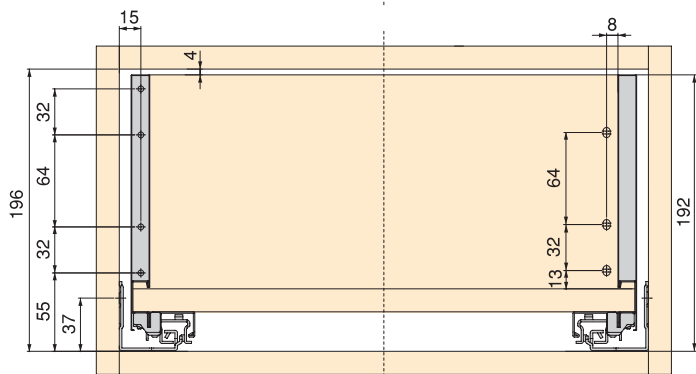
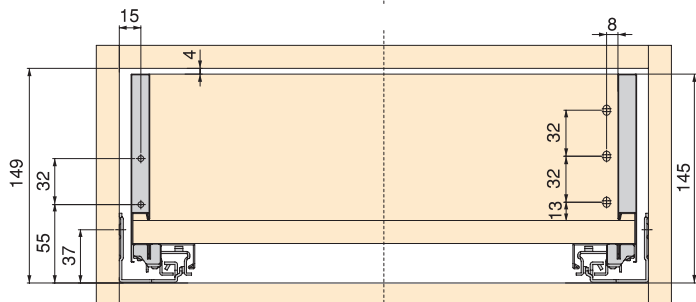
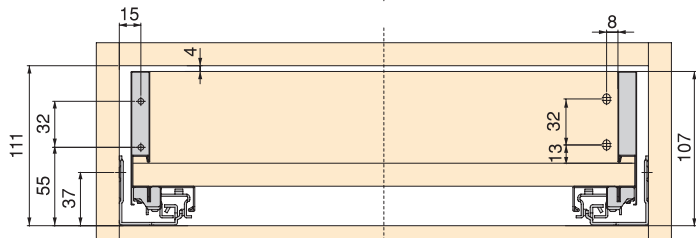
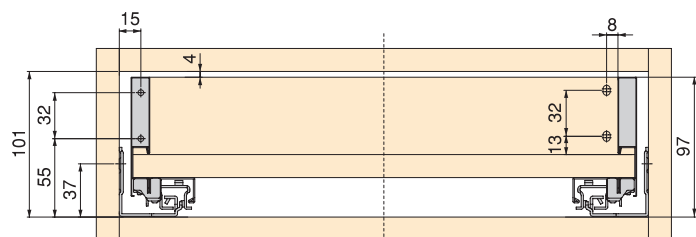
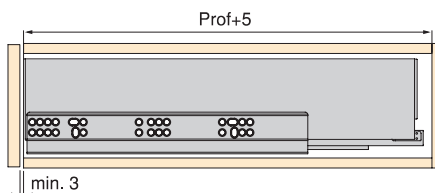
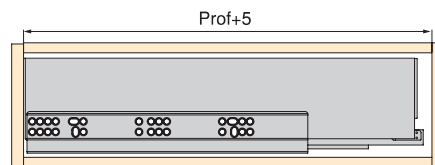

H	Ht
83	53
93	63
131	101
178	148

Adjustment / Regolazione / Regulación / Réglage / Regulação / Dostosowanie

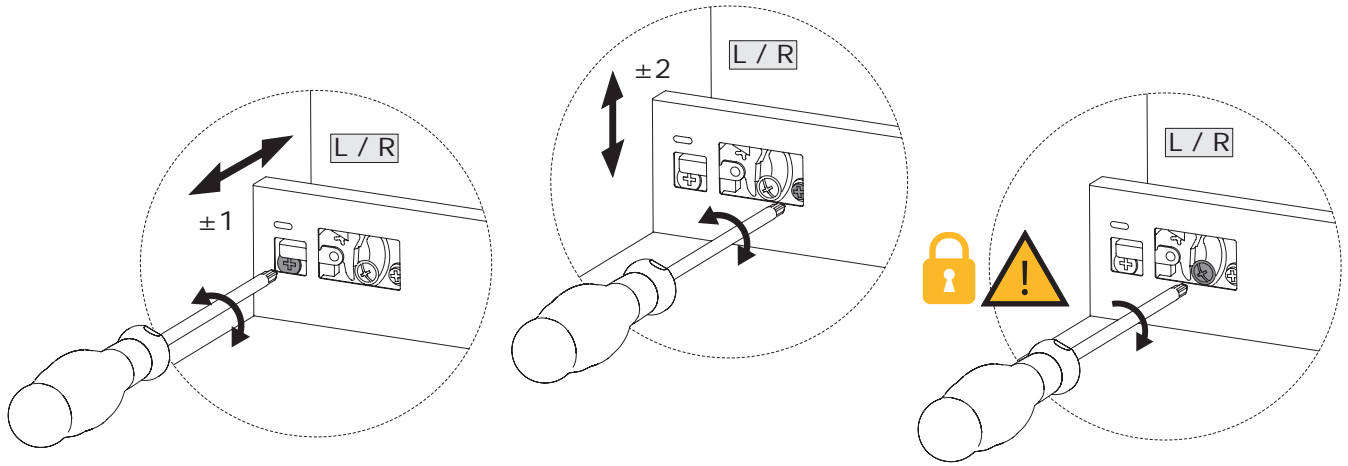

Dismounting / Smontaggio / Desmontaje / Démontage / Desmontagem / Demontaž

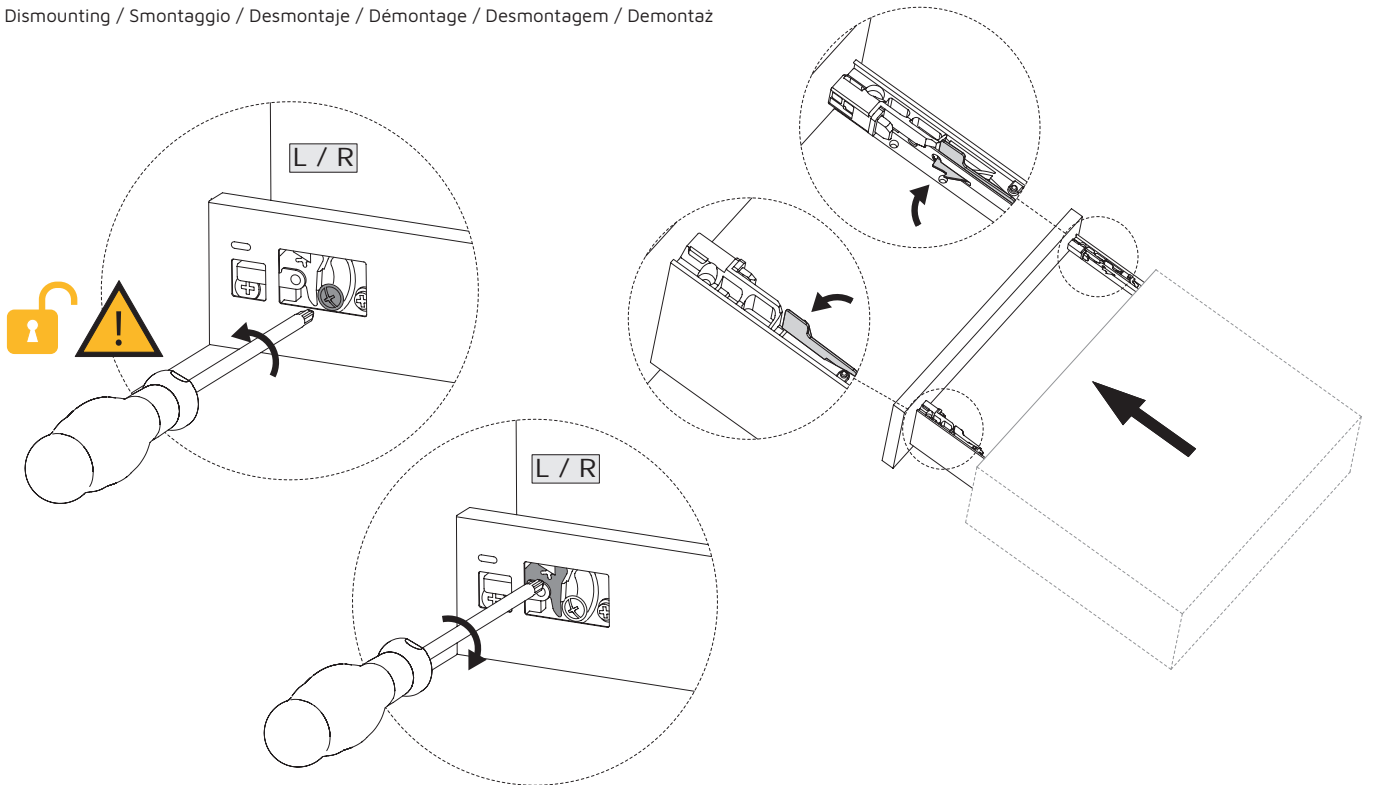

Adjustment tilt front / Regolazione de l'inclinazione del frontale / Ajuste inclinación frente / Réglage de la façade / Regulação frente/ Prząd regulacji nachylenia

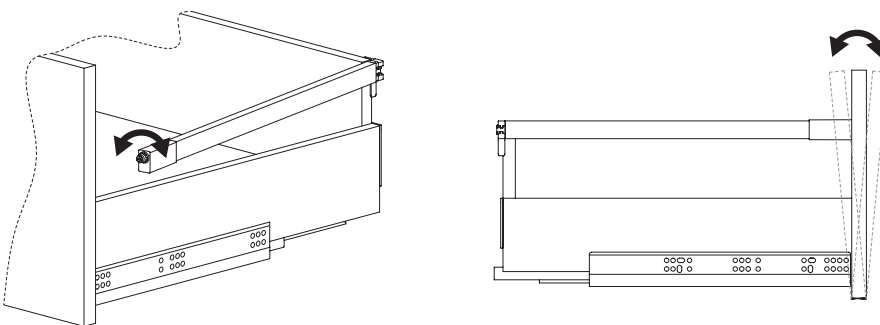

Assembly

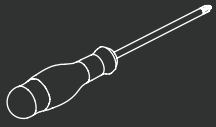

**where
creation
begins**



Emuca S.R.L

Via Messico, 80 • 35127 Padova (ITALIA)
T. +39 049 8702800 • F. +39 049 87 03019
www.emuca.it

Emuca Ltd.

75 Springfield Road • Chelmsford • Essex
CM2 6JG (UK)
T. +44 1268 530 674 • F. +44 1268 282 592
www.emuca.co.uk

Emuca S.A.

Pl. El Oliveral - c/H, 4 • Apartado de correos 176
46394 Riba-Roja del Túria • Valencia (ESPAÑA)
T. +34 96 166 70 19 • F. +34 96 166 71 82
www.emuca.es

Emuca S.A.R.L

Parc de l'Aubinière • 2 Avenue des Améthystes
44338 Nantes Cedex 03 (FRANCE)
T. +33 2 49 88 07 35 • F. +33 2 72 22 02 24
www.emuca.fr

Emuca Lda.

AV. da Liberdade n° 38, 4° • 1250-145 Lisboa (PORTUGAL)
T. +351 211 203 940 • F. +34 96 166 71 82
www.emuca.pt

04/2022



CERTIQUALITY
È MEMBRO DELLA
FEDERAZIONE DISQ

